



April 2000
Revised April 2003

NC7WZ132 TinyLogic® UHS Dual 2-Input NAND Gate with Schmitt Trigger Inputs

General Description

The NC7WZ132 is a dual 2-Input NAND Gate from Fairchild's Ultra High Speed Series of TinyLogic®. The device is fabricated with advanced CMOS technology to achieve ultra high speed with high output drive while maintaining low static power dissipation over a broad V_{CC} operating range. The device is specified to operate over the 1.65V to 5.5V V_{CC} operating range. The inputs and output are high impedance when V_{CC} is 0V. Inputs tolerate voltages up to 7V independent of V_{CC} operating voltage. Schmitt trigger inputs achieve typically 1V hysteresis between the positive-going and negative-going input threshold voltage at 5V V_{CC} .

Features

- Space saving US8 surface mount package
- MicroPak™ leadless package
- Ultra High Speed; t_{PD} 3.1 ns typ into 50 pF at 5V V_{CC}
- High Output Drive; ± 24 mA at 3V V_{CC}
- Broad V_{CC} Operating Range; 1.65V to 5.5V
- Matches the performance of LCX when operated at 3.3V V_{CC}
- Power down high impedance inputs/output
- Overvoltage tolerant inputs facilitate 5V to 3V translation
- Patented noise/EMI reduction circuitry implemented
- Schmitt trigger inputs are tolerant of slow changing input signals

Ordering Code:

Order Number	Package Number	Product Code Top Mark	Package Description	Supplied As
NC7WZ132K8X	MAB08A	WZD2	8-Lead US8, JEDEC MO-187, Variation CA 3.1mm Wide	3k Units on Tape and Reel
NC7WZ132L8X (Preliminary)	MAC08A	T5	8-Lead MicroPak, 1.6 mm Wide	5k Units on Tape and Reel

TinyLogic® is a registered trademark of Fairchild Semiconductor Corporation.
MicroPak™ is a trademark of Fairchild Semiconductor Corporation.

NC7WZ132 TinyLogic® UHS Dual 2-Input NAND Gate with Schmitt Trigger Inputs

Logic Symbol

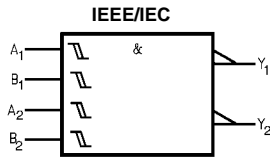

Pin Descriptions

Pin Names	Description
A _n , B _n	Inputs
Y _n	Output

Function Table

$$Y = \overline{AB}$$

Inputs		Output
A	B	Y
L	L	H
L	H	H
H	L	H
H	H	L

H = HIGH Logic Level

L = LOW Logic Level

Connection Diagrams

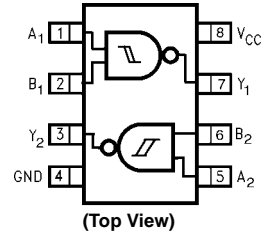

Pin One Orientation Diagram

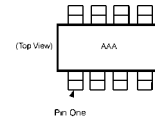

AAA represents Product Code Top Mark - see ordering code

Note: Orientation of Top Mark determines Pin One location. Read the top product code mark left to right, Pin One is the lower left pin (see diagram).

Pad Assignments for MicroPak

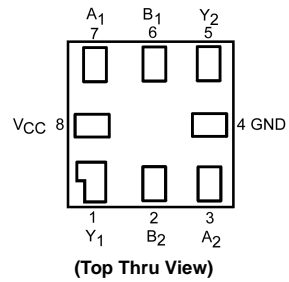

Absolute Maximum Ratings (Note 1)		Recommended Operating Conditions (Note 2)	
Supply Voltage (V_{CC})	-0.5V to +7V	Supply Voltage Operating (V_{CC})	1.65V to 5.5V
DC Input Voltage (V_{IN})	-0.5V to +7V	Supply Voltage Data Retention (V_{CC})	1.5V to 5.5V
DC Output Voltage (V_{OUT})	-0.5V to +7V	Input Voltage (V_{IN})	0V to 5.5V
DC Input Diode Current (I_{IK})		Output Voltage (V_{OUT})	0V to V_{CC}
@ $V_{IN} < -0.5V$	-50 mA	Operating Temperature (T_A)	-40°C to +85°C
DC Output Diode Current (I_{OK})		Thermal Resistance (θ_{JA})	250°C/W
@ $V_{OUT} < -0.5V$	-50 mA		
DC Output Current (I_{OUT})	± 50 mA		
DC V_{CC}/GND Current (I_{CC}/I_{GND})	± 100 mA		
Storage Temperature (T_{STG})	-65°C to +150°C		
Junction Temperature under Bias (T_J)	150°C		
Junction Lead Temperature (T_L); (Soldering, 10 seconds)	260°C		
Power Dissipation (P_D) @ +85°C	250 mW		

Note 1: Absolute maximum ratings are DC values beyond which the device may be damaged or have its useful life impaired. The datasheet specifications should be met, without exception, to ensure that the system design is reliable over its power supply, temperature, and output/input loading variables. Fairchild does not recommend operation outside datasheet specifications.

Note 2: Unused inputs must be held HIGH or LOW. They may not float.

DC Electrical Characteristics

Symbol	Parameter	V_{CC} (V)	$T_A = +25^\circ\text{C}$			$T_A = -40^\circ\text{C to } +85^\circ\text{C}$		Units	Conditions	
			Min	Typ	Max	Min	Max			
V_P	Positive Threshold Voltage	1.65	0.6	0.99	1.4	0.6	1.4	V		
		2.3	1.0	1.39	1.8	1.0	1.8			
		3.0	1.3	1.77	2.2	1.3	2.2			
		4.5	1.9	2.49	3.1	1.9	3.1			
		5.5	2.2	2.96	3.6	2.2	3.6			
V_N	Negative Threshold Voltage	1.65	0.2	0.53	0.9	0.2	0.9	V		
		2.3	0.4	0.78	1.15	0.4	1.15			
		3.0	0.6	1.02	1.5	0.6	1.5			
		4.5	1.0	1.48	2.0	1.0	2.0			
		5.5	1.2	1.76	2.3	1.2	2.3			
V_H	Hysteresis Voltage	1.65	0.15	0.46	0.9	0.15	0.9	V		
		2.3	0.25	0.61	1.1	0.25	1.1			
		3.0	0.4	0.75	1.2	0.4	1.2			
		4.5	0.6	1.01	1.5	0.6	1.5			
		5.5	0.7	1.20	1.7	0.7	1.7			
V_{OH}	HIGH Level Output Voltage	1.65	1.55	1.65		1.55		V	$V_{IN} = V_{IL}$	$I_{OH} = -100 \mu\text{A}$
		2.3	2.2	2.3		2.2				
		3.0	2.9	3.0		2.9				
		4.5	4.4	4.5		4.4				
		5.5	5.0	5.5		5.0				
	1.65	1.29	1.52		1.29		V		$I_{OH} = -4 \text{ mA}$	
	2.3	1.9	2.15		1.9				$I_{OH} = -8 \text{ mA}$	
	3.0	2.4	2.80		2.4				$I_{OH} = -16 \text{ mA}$	
	3.0	2.3	3.68		2.3				$I_{OH} = -24 \text{ mA}$	
	4.5	3.8	4.20		3.8				$I_{OH} = -32 \text{ mA}$	
V_{OL}	LOW Level Output Voltage	1.65		0.0	0.10		0.10	V	$V_{IN} = V_{IH}$	$I_{OL} = 100 \mu\text{A}$
		2.3		0.0	0.10		0.10			
		3.0		0.0	0.10		0.10			
		4.5		0.0	0.10		0.10			
	1.65		0.08	0.24		0.24	V		$I_{OL} = 4 \text{ mA}$	
	2.3		0.10	0.3		0.3			$I_{OL} = 8 \text{ mA}$	
	3.0		0.15	0.4		0.4			$I_{OL} = 16 \text{ mA}$	
3.0		0.22	0.55		0.55		$I_{OL} = 24 \text{ mA}$			
4.5		0.22	0.55		0.55		$I_{OL} = 32 \text{ mA}$			
I_{IN}	Input Leakage Current	0 to 5.5			± 0.1		± 1	μA	$V_{IN} = 5.5V, GND$	
I_{OFF}	Power Off Leakage Current	0.0			1		10	μA	V_{IN} or $V_{OUT} = 5.5V$	

DC Electrical Characteristics (Continued)

Symbol	Parameter	V _{CC} (V)	T _A = +25°C			T _A = -40°C to +85°C		Units	Conditions
			Min	Typ	Max	Min	Max		
I _{CC}	Quiescent Supply Current	1.65 to 5.5	1			10		μA	V _{IN} = 5.5V, GND

AC Electrical Characteristics

Symbol	Parameter	V _{CC} (V)	T _A = +25°C			T _A = -40°C to +85°C		Units	Conditions	Figure Number
			Min	Typ	Max	Min	Max			
t _{PLH} , t _{PHL}	Propagation Delay	1.8 ± 0.15	3.0	7.1	13.0	3.0	13.5	ns	C _L = 15 pF, R _L = 1 MΩ	Figures 1, 3
		2.5 ± 0.2	2.0	4.5	7.5	2.0	8.0			
		3.3 ± 0.3	1.2	3.4	5.0	1.2	5.5			
		5.0 ± 0.5	0.8	2.6	3.8	0.8	4.2			
t _{PLH} , t _{PHL}	Propagation Delay	3.3 ± 0.3	1.8	4.0	5.8	1.8	6.3	ns	C _L = 50 pF, R _L = 500Ω	Figures 1, 3
		5.0 ± 0.5	1.2	3.1	4.5	1.2	4.9			
C _{IN}	Input Capacitance	0	2.5					pF		
C _{PD}	Power Dissipation Capacitance	3.3	15					pF	(Note 3)	Figure 2
		5.0	18							

Note 3: C_{PD} is defined as the value of the internal equivalent capacitance which is derived from dynamic operating current consumption (I_{CCD}) at no output loading and operating at 50% duty cycle. (See Figure 2.) C_{PD} is related to I_{CCD} dynamic operating current by the expression:
 $I_{CCD} = (C_{PD})(V_{CC})(f_{IN}) + (I_{CC} \text{static})$.

AC Loading and Waveforms

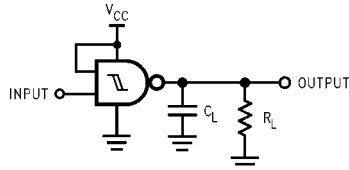

C_L includes load and stray capacitance
 Input PRR = 1.0 MHz; t_w = 500 ns

FIGURE 1. AC Test Circuit

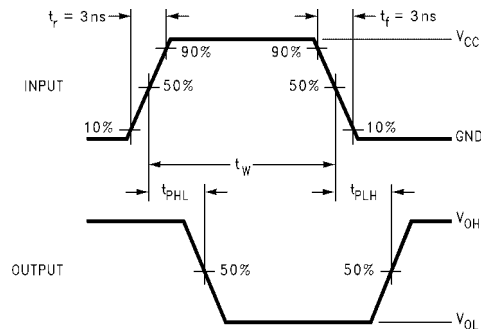
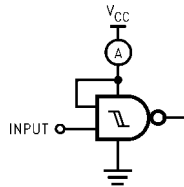

FIGURE 3. AC Waveforms



Input = AC Waveform; t_r = t_f = 1.8 ns;
 PRR = 10 MHz; Duty Cycle = 50%

FIGURE 2. I_{CCD} Test Circuit

Tape and Reel Specification

Tape Format for US8

Package Designator	Tape Section	Number Cavities	Cavity Status	Cover Tape Status
K8X	Leader (Start End)	125 (typ)	Empty	Sealed
	Carrier	3000	Filled	Sealed
	Trailer (Hub End)	75 (typ)	Empty	Sealed

TAPE DIMENSIONS inches (millimeters)

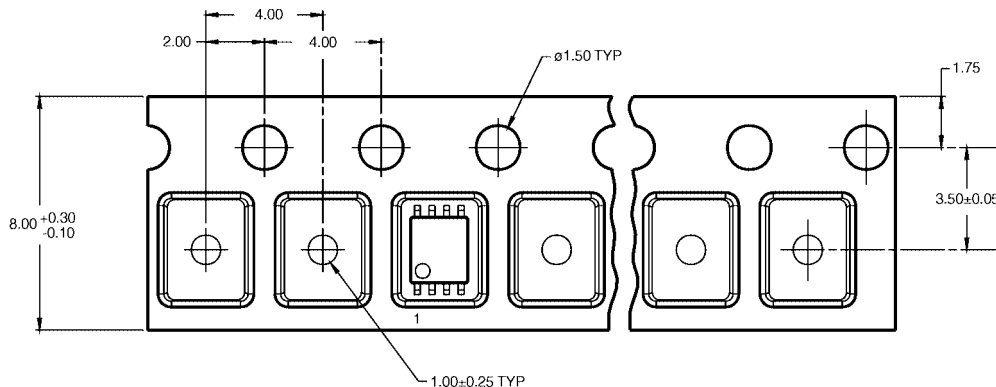

Tape Format for MicroPak

Package Designator	Tape Section	Number Cavities	Cavity Status	Cover Tape Status
L8X	Leader (Start End)	125 (typ)	Empty	Sealed
	Carrier	3000	Filled	Sealed
	Trailer (Hub End)	75 (typ)	Empty	Sealed

TAPE DIMENSIONS inches (millimeters)

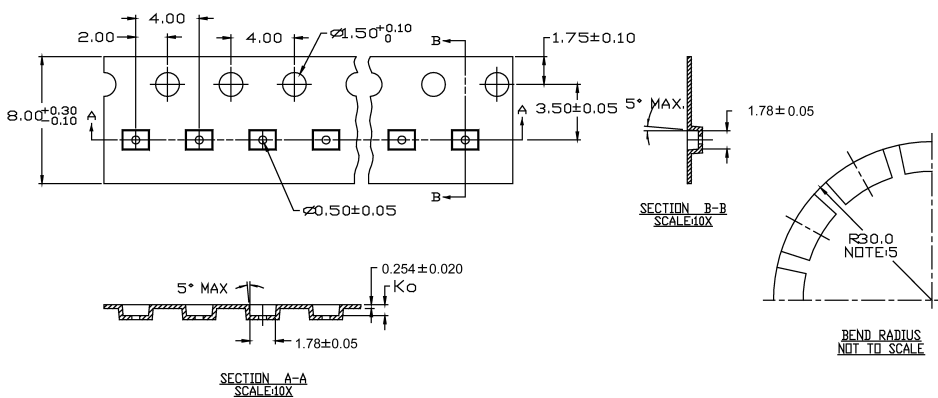

Tape and Reel Specification (Continued)

REEL DIMENSIONS inches (millimeters)

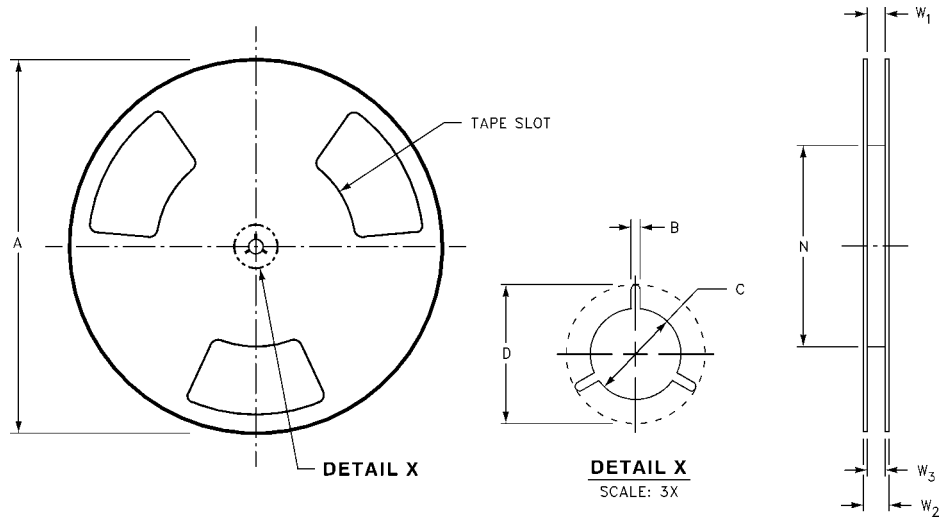

Tape Size	A	B	C	D	N	W1	W2	W3
8 mm	7.0 (177.8)	0.059 (1.50)	0.512 (13.00)	0.795 (20.20)	2.165 (55.00)	$0.331 + 0.059/-0.000$ ($8.40 + 1.50/-0.00$)	0.567 (14.40)	$W1 + 0.078/-0.039$ ($W1 + 2.00/-1.00$)

Physical Dimensions inches (millimeters) unless otherwise noted

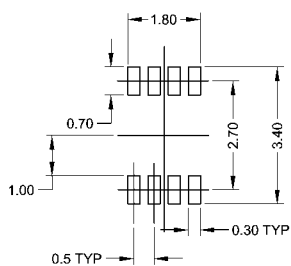
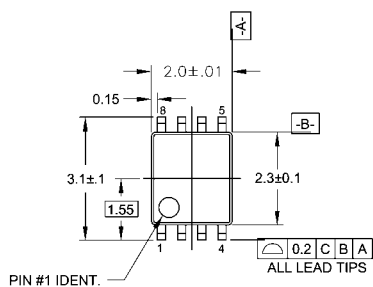

LAND PATTERN RECOMMENDATION

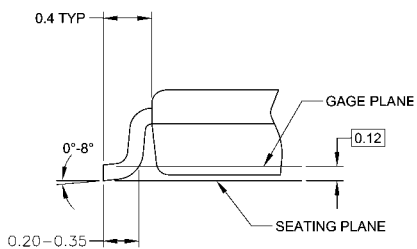
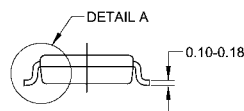
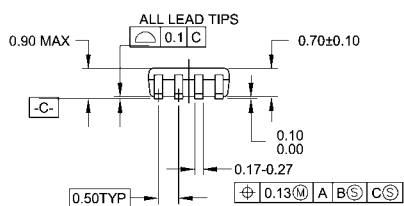

NOTES:

- A. CONFORMS TO JEDEC REGISTRATION MO-187
- B. DIMENSIONS ARE IN MILLIMETERS.
- C. DIMENSIONS ARE EXCLUSIVE OF BURRS, MOLD FLASH, AND TIE BAR EXTRUSIONS.
- D. DIMENSIONS AND TOLERANCES PER ANSI Y14.5M, 1982.

MAB08AREVC

**8-Lead US8, JEDEC MO-187, Variation CA 3.1mm Wide
Package Number MAB08A**

Physical Dimensions inches (millimeters) unless otherwise noted (Continued)

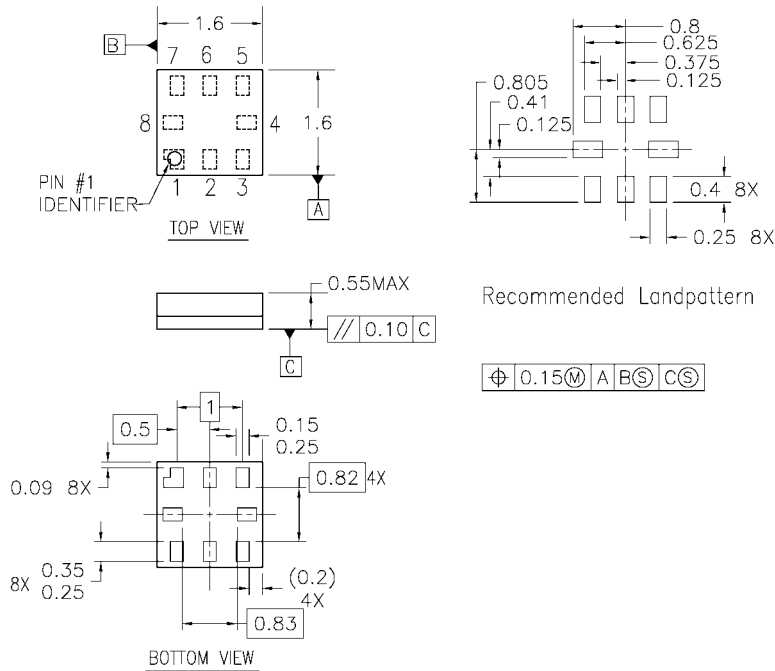

- Notes:
1. PACKAGE REGISTRATION WITH JEDEC IS ANTICIPATED
 2. DIMENSIONS ARE IN MILLIMETERS
 3. DRAWING CONFORMS TO ASME Y.14M-1994

MAC08AREVB

**8-Lead MicroPak, 1.6 mm Wide
Package Number MAC08A
(Preliminary)**

Fairchild does not assume any responsibility for use of any circuitry described, no circuit patent licenses are implied and Fairchild reserves the right at any time without notice to change said circuitry and specifications.

LIFE SUPPORT POLICY

FAIRCHILD'S PRODUCTS ARE NOT AUTHORIZED FOR USE AS CRITICAL COMPONENTS IN LIFE SUPPORT DEVICES OR SYSTEMS WITHOUT THE EXPRESS WRITTEN APPROVAL OF THE PRESIDENT OF FAIRCHILD SEMICONDUCTOR CORPORATION. As used herein:

1. Life support devices or systems are devices or systems which, (a) are intended for surgical implant into the body, or (b) support or sustain life, and (c) whose failure to perform when properly used in accordance with instructions for use provided in the labeling, can be reasonably expected to result in a significant injury to the user.
2. A critical component in any component of a life support device or system whose failure to perform can be reasonably expected to cause the failure of the life support device or system, or to affect its safety or effectiveness.

www.fairchildsemi.com